

## Surface distribution board, 2 modules. Smoked door.

Surface-mounted board with 2 modules. White box and frame with smoked door. Compact and sturdy design suitable for small visible installations. External dimensions 62 x 140 x 85 mm.



### Features

Installation method	Surface
Use	Domestic / Tertiary
Location type	Inside
No. Modules (18 mm)	2
Modules per row	2
Metallic DIN profile	Yes
Dimensions outside (mm) (width x height x depth)	62x140x85
Dimensions (mm)	See sketch
Case material	Insulation
Frame and door material	Insulation
Case color	White
Cap color	White
Door color	Fume
Door opening	Vertical
Battens included	No
Ticket type	Pre-punched
Fixation System (For surface)	Inside
Sealable	Not
Lid closure system	Metal screw

Door closing system	A Pressure
Reversible door	Yes
Possibility of putting lock	Not
Separate covers or doors on the boxes	Yes
Possibility of mounting DIN rail	Yes (included)
Common applications	Indoor domestic / tertiary environment (Interior of home, offices, shops, etc.)
Additional dimensions (mm)	See sketch

## Technical data

Protection Degree (IK)	IK08
Insulation class	Class II
Fire resistance (GWEPT)	650 °C
Heat resistance (Ball pressure)	70 °C
Installation temperature	-5 °C -> +60 °C
Ambient operating temperature	-5 °C ; +60 °C
Work stress	<1000 Vac ; 1500 Vdc
Free of halogens	Yes

## Regulations

CE marking	Yes
UK marking	Yes
CMim marking	Yes
According to Regulations UNE/EN	UNE-EN 62208:2012
In accordance with the Low Voltage Electrotechnical Regulations (REBT)	Yes
According to European Directive 2014/35 / EU. Low voltage directive	Yes

## Sustainability

According to European Directive 2011/65/UE (RoHS)	The Directive 2011/65/EU (RoHS II) is not applicable as it does not correspond to the definition of Electrical and Electronical Equipment (EEE) as per article 3.1
---	--

According to European Directive  
2012/19/UE (RAEE2)

Not applicable because it does not meet the definition of Electrical and Electronic  
Equipment (EEE) as described in Article 3.1(a) of Directive 2012/19/EU (WEEE II).





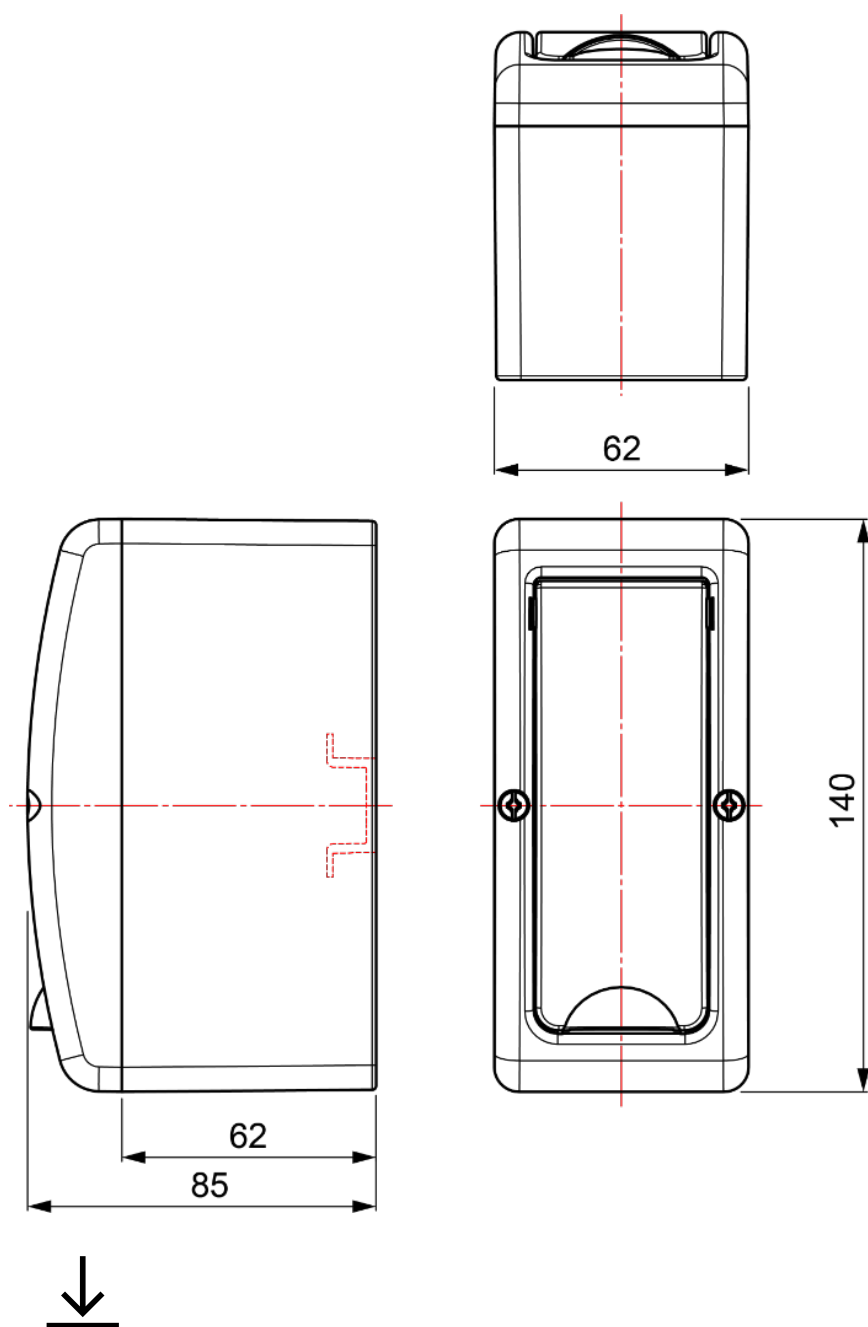

## Logistics and packaging

Unit EAN code	8423220003538
EAN code container	8423220003538
EAN code packaging	18423220003535
Units packaging	1
Units carton	48
Pallet Units	1680
Packaging Measures cm	59,5x37,5x20
Unit weight (g)	108
Container Weight (Kg)	0,108
Packaging Weight (Kg)	5,724
Tariff code	85371098

## Sketch



## Documentation and downloads

- |   |  |
|---|--|
|  Assembly instructions (2.09MB) |  Included accessories (0.09MB)                  |
|  Safety Information (0.38MB)    |  Dimensions table (0.15MB)                      |
|  Series replenishments (0.04MB) |  Distribution boards Arelos range (Solera) 2020 |