

Surface distribution board, 4 modules.

Compact surface-mounted board with 4 modules. White finish enclosure ideal for basic circuits and minimal surface wiring. Easy to install and suitable for limited spaces. External dimensions 150 x 225 x 95 mm.



Features

Installation method	Surface
Use	Domestic / Tertiary
Location type	Inside
No. Modules (18 mm)	4
Modules per row	4
Metallic DIN profile	Yes
Dimensions outside (mm) (width x height x depth)	150x225x95
Dimensions (mm)	See sketch
Case material	Insulation
Frame and door material	Insulation
Case color	White
Cap color	White
Door color	White
Door opening	Vertical
Battens included	No
Ticket type	Pre-punched
Fixation System (For surface)	Inside
Sealable	Not
Lid closure system	Metal screw

Door closing system	A Pressure
Reversible door	Yes
Possibility of mounting strips	Yes (not included)
Possibility of putting lock	Yes (not included)
Separate covers or doors on the boxes	Yes
Possibility of mounting DIN rail	Yes (included)
Common applications	Indoor domestic / tertiary environment (Interior of home, offices, shops, etc.)
Additional dimensions (mm)	See sketch

Technical data

Protection Degree (IK)	IK08
Insulation class	Class II
Fire resistance (GWEPT)	650 °C
Heat resistance (Ball pressure)	70 °C
Installation temperature	-5 °C -> +60 °C
Ambient operating temperature	-5 °C ; +60 °C
Work stress	<1000 Vac ; 1500 Vdc
Thermal power dissipated	14 W
Free of halogens	Yes

Regulations

CE marking	Yes
UK marking	Yes
CMim marking	Yes
According to Regulations UNE/EN	UNE-EN 62208:2012
In accordance with the Low Voltage Electrotechnical Regulations (REBT)	Yes
According to European Directive 2014/35 / EU. Low voltage directive	Yes

Sustainability

According to European Directive 2011/65/UE (RoHS)	The Directive 2011/65/EU (RoHS II) is not applicable as it does not correspond to the definition of Electrical and Electronical Equipment (EEE) as per article 3.1
According to European Directive 2012/19/UE (RAEE2)	Not applicable because it does not meet the definition of Electrical and Electronic Equipment (EEE) as described in Article 3.1(a) of Directive 2012/19/EU (WEEE II).





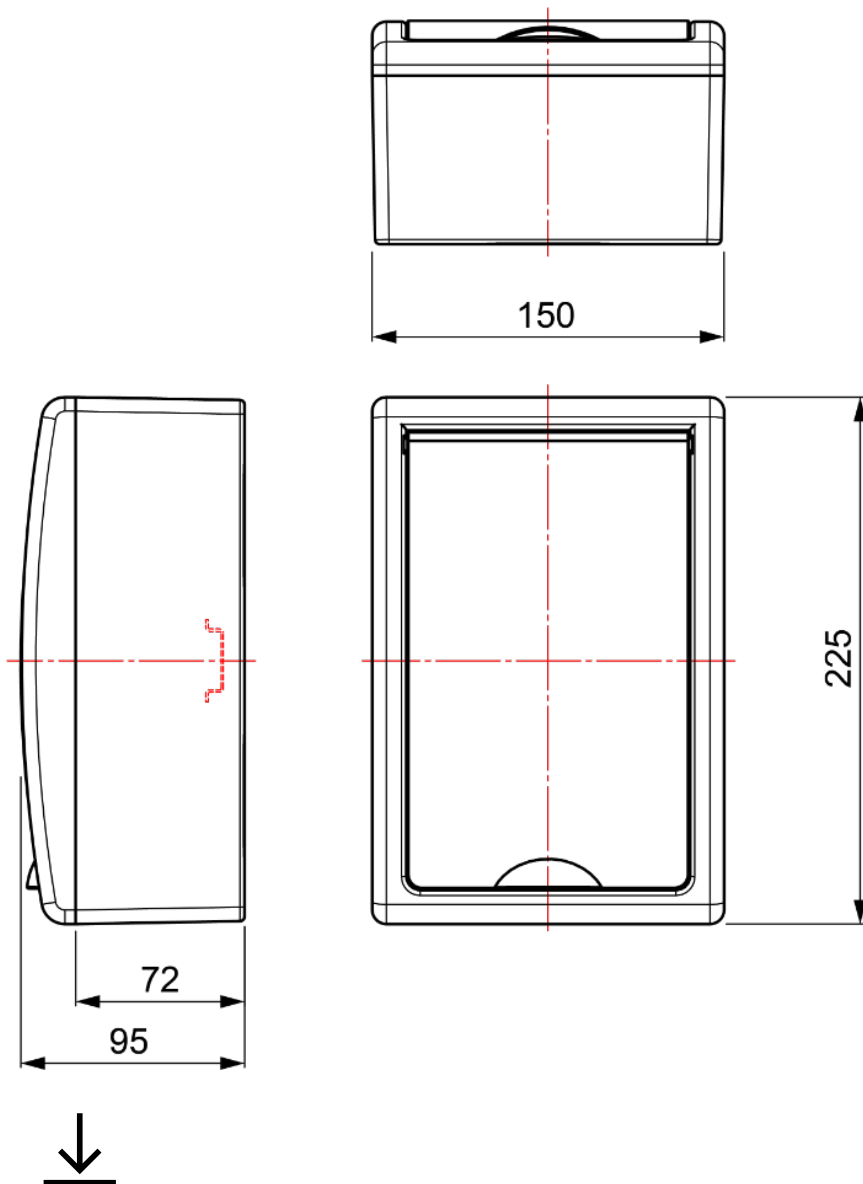

Logistics and packaging

Unit EAN code	8423220017528
EAN code container	8423220017528
EAN code packaging	18423220017525
Units packaging	1
Units carton	30
Pallet Units	360
Packaging Measurements cm	9,5x15x22,7
Packaging Measures cm	59,5x42,5x51
Unit weight (g)	510
Container Weight (Kg)	0,5936
Packaging Weight (Kg)	18,732
Tariff code	85371098

Sketch



Documentation and downloads

- | | |
|---|--|
|  Assembly instructions (2.09MB) |  Included accessories (0.09MB) |
|  Safety Information (0.38MB) |  Dimensions table (0.15MB) |
|  Series replenishments (0.04MB) |  Distribution boards Arelos range (Solera) 2020 |