

Flush distribution board, 4 modules.

Flush-mounted board with 4 modules. White frame and door. Flush dimensions 125 x 195 x 72 mm. Ideal for basic modular installations requiring recessed mounting.



Features

Installation method	Flush in work
Use	Domestic / Tertiary
Location type	Inside
No. Modules (18 mm)	4
Modules per row	4
Metallic DIN profile	Yes
Dimensions gap (mm) (Width x Height x Depth)	125x195x72
Dimensions (mm)	See sketch
Case material	Insulation
Frame and door material	Insulation
Case color	Black
Cap color	White
Door color	White
Door opening	Vertical
Battens included	No
Ticket type	Unfathomable
Fixation System (For surface)	Inside
Sealable	Not
Lid closure system	Metal screw

Door closing system	A Pressure
Reversible door	Yes
Separate covers or doors on the boxes	Yes
Possibility of mounting DIN rail	Yes (included)
Common applications	Indoor domestic / tertiary environment (Interior of home, offices, shops, etc.)
Additional dimensions (mm)	See sketch

Technical data

Protection Degree (IK)	IK08
Insulation class	Class II
Fire resistance (GWEPT)	650 °C
Heat resistance (Ball pressure)	70 °C
Installation temperature	-5 °C -> +60 °C
Ambient operating temperature	-5 °C ; +60 °C
Work stress	400 Vac-1000 Vdc
Thermal power dissipated	8 W
Free of halogens	Yes

Regulations

CE marking	Yes
UK marking	Yes
CMim marking	Yes
According to Regulations UNE/EN	UNE-EN 62208:2012
In accordance with the Low Voltage Electrotechnical Regulations (REBT)	Yes
According to European Directive 2014/35 / EU. Low voltage directive	Yes

Sustainability

According to European Directive 2011/65/UE (RoHS)	The Directive 2011/65/EU (RoHS II) is not applicable as it does not correspond to the definition of Electrical and Electronical Equipment (EEE) as per article 3.1
---------------------------------------------------	--------------------------------------------------------------------------------------------------------------------------------------------------------------------

According to European Directive
2012/19/UE (RAEE2)

Not applicable because it does not meet the definition of Electrical and Electronic
Equipment (EEE) as described in Article 3.1(a) of Directive 2012/19/EU (WEEE II).





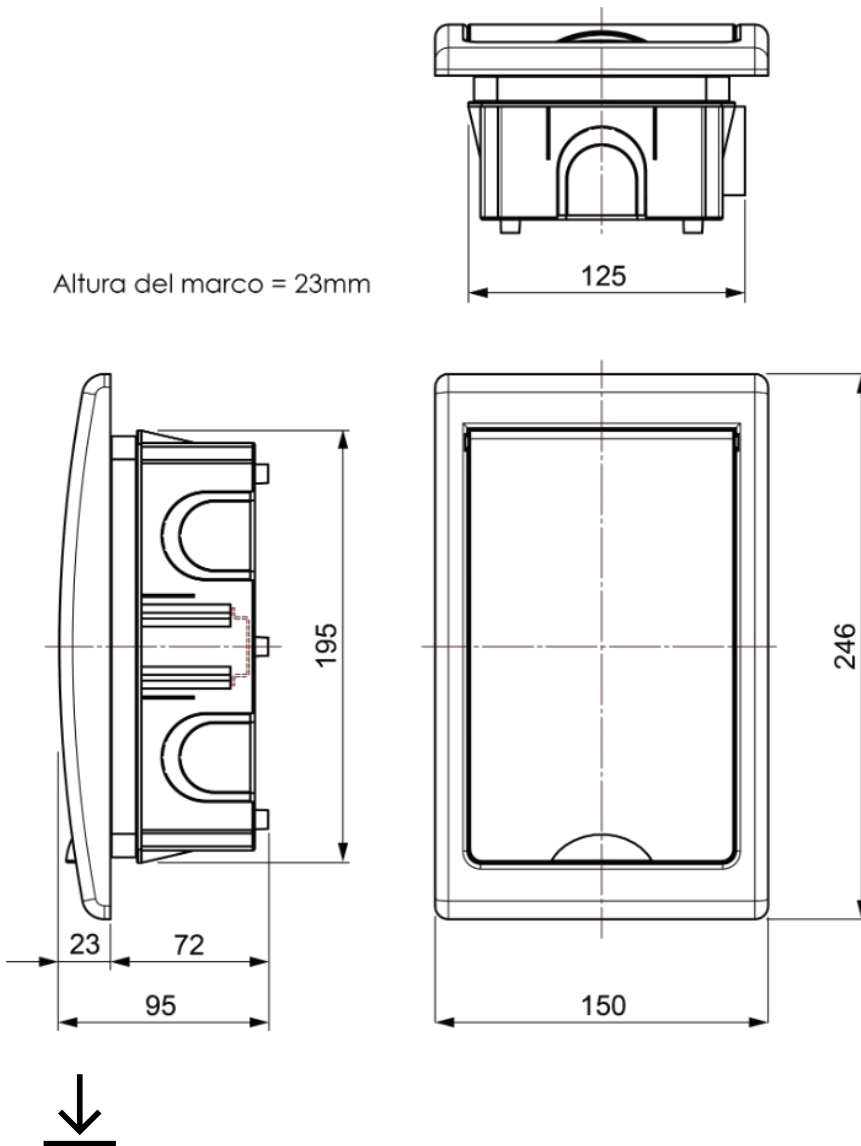

Logistics and packaging

Unit EAN code	8423220017504
EAN code container	8423220017504
EAN code packaging	18423220017501
Units packaging	1
Units carton	30
Pallet Units	360
Packaging Measurements cm	9,5x15x22,7
Packaging Measures cm	59,5x42,5x51
Unit weight (g)	1106
Container Weight (Kg)	1,1896
Packaging Weight (Kg)	36,612
Tariff code	85371098

Sketch



Documentation and downloads

-  [Assembly instructions \(2.09MB\)](#)
-  [Safety Information \(0.38MB\)](#)
-  [Dimensions table \(0.15MB\)](#)
-  [Distribution boards Arelos range \(Solera\) 2020](#)
-  [Included accessories \(0.14MB\)](#)
-  [Link options for enclosures \(0.13MB\)](#)
-  [Series replenishments \(0.04MB\)](#)