

Mobile industrial socket 3P+N+E, 32A 400V~. IP67.

Mobile industrial socket 3P+N+E, 32A 400V~. IP67.



Features

Common applications	Industrial environments (factories, warehouses, etc.)
Type	Mobile industrial socket
No. of poles	3P + N + T
Type of terminal connection	Screw connection
Earth position	6h
Nominal current	32A
Nominal voltage	400V
Color	Red

Technical data

Protection Degree (IK)	IK09
Impact shock resistance	Strong
Fire resistance (GWEPT)	850 °C
Heat resistance (Ball pressure)	125 °C
Ambient operating temperature	-5 °C ; +40 °C
Dimensional stability	-25 °C -> +80 °C
Free of halogens	Yes

Regulations

CE marking	Yes
------------	-----

UK marking	Yes
CMim marking	Yes
According to Regulations UNE/EN	UNE-EN 60309-1:2023 UNE-EN 60309-2:2023
In accordance with the Low Voltage Electrotechnical Regulations (REBT)	Yes
According to European Directive 2014/35 / EU. Low voltage directive	Yes

Sustainability

According to European Directive 2011/65/UE (RoHS)	Yes
According to European Directive 2012/19/UE (RAEE2)	Yes
According to Regulations (RoHS)	UNE-EN IEC 63000:2022

Logistics and packaging

Unit EAN code	8423220042896
EAN code container	8423220042896
EAN code packaging	18423220042893
Units packaging	1
Units carton	10
Pallet Units	99999
Packaging Measures cm	33x26x17
Unit weight (g)	340,2
Container Weight (Kg)	0,3402
Packaging Weight (Kg)	3,612
Tariff code	85366990

Sketch

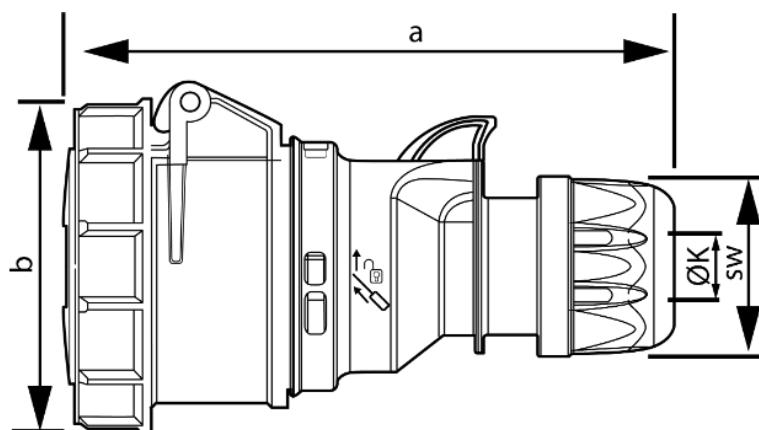

Ampere	16				32			
Pole	3	4	5	7	3	4	5	7
a [mm]	132	139	147	147	163	163	171	171
b [mm]	78	84	92	92	96	96	102	102
K [mm]	6-15	6-15	8-16	8-16	11,5-20	11,5-20	11,5-22	11,5-22
SW [mm]	42	42	42	42	50	50	50	50



Documentation and downloads



Safety Information (0.38MB)