

Residual Current Circuit-Breaker 2P, 63A. AC class. Sensitivity 300 mA

Residual Current Circuit-Breaker 2P, 63A. AC class. Sensitivity 300 mA 2 modules. 230V AC (50 - 60 Hz). Breaking capacity 6kA.



Features

Common applications	Indoor domestic / tertiary environment (Interior of home, offices, shops, etc.)
Mechanical durability	15.000 cycles
Protection type (modular)	Diferential switch
No. of poles	1P + N
Modules (18 mm)	2
Neutral position	Left
Network type	Alternating current (ac)
Sensitivity (Leakage current)	300 mA
Short circuit capacity	6 kA
Protection type	Class AC
Delay type	Instant (No delay)
Fixation	35mm DIN rail
Connection capacity	Up to 35 mm ²
Possibility of using pin type combs	Yes
Nominal current	63A
Nominal voltage	230 Vca - (50/60 Hz)

Technical data

Fire resistance (GWEPT)	960 °C
-------------------------	--------

Ambient operating temperature	-5 °C ; +40 °C
Free of halogens	Yes

Regulations

CE marking	Yes
UK marking	Yes
CMim marking	Yes
According to Regulations UNE/EN	UNE-EN 61008-1:2013;UNE-EN IEC 61543:2023
In accordance with the Low Voltage Electrotechnical Regulations (REBT)	Yes
AENOR certificate	Yes
CB certificate	Yes
According to European Directive 2014/35 / EU. Low voltage directive	Yes

Sustainability

According to European Directive 2011/65/UE (RoHS)	Yes
According to European Directive 2012/19/UE (RAEE2)	Yes
According to Regulations (RoHS)	UNE-EN IEC 63000:2022
According to European Directive 2014/30/UE. (CEM)	Yes

Logistics and packaging

Unit EAN code	8423220093584
EAN code container	8423220093584
EAN code packaging	18423220093581
Units packaging	1
Units carton	60
Pallet Units	1500
Packaging Measures cm	43x20,5x27
Unit weight (g)	432,8

Container Weight (Kg)	0,4328
Packaging Weight (Kg)	26,106
Tariff code	85362010

Sketch

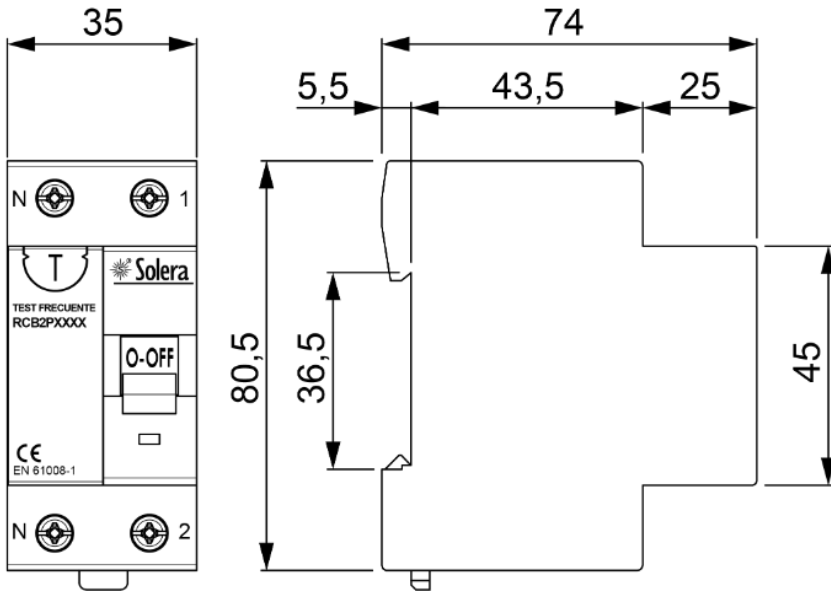

Documentation and downloads



Assembly instructions (0.26MB)



Safety Information (0.38MB)



Certificate (0.72MB)