



Junction boxes / *Boîtes étanches*



WITH CONES
AVEC GRADINS

Pg. 106



WITHOUT CONES
SANS GRADINS

Pg. 108



BLACK (GWT 850°C)
NOIR (GWT 850°C)

Pg. 110



WITH TRANSPARENT LID
AVEC COUVERCLE TRANSPARENT

Pg. 112



WITH DIN RAIL
AVEC RAIL DIN

Pg. 112



SPECIAL ASSEMBLY
ASSEMBLAGE SPÉCIAL

Pg. 116



ACCESSORIES
ACCESSOIRES

Pg. 118

Complementary products



Pg. 266



Pg. 60



Pg. 118



Pg. 276

Product characteristics / *Caractéristiques du produit*

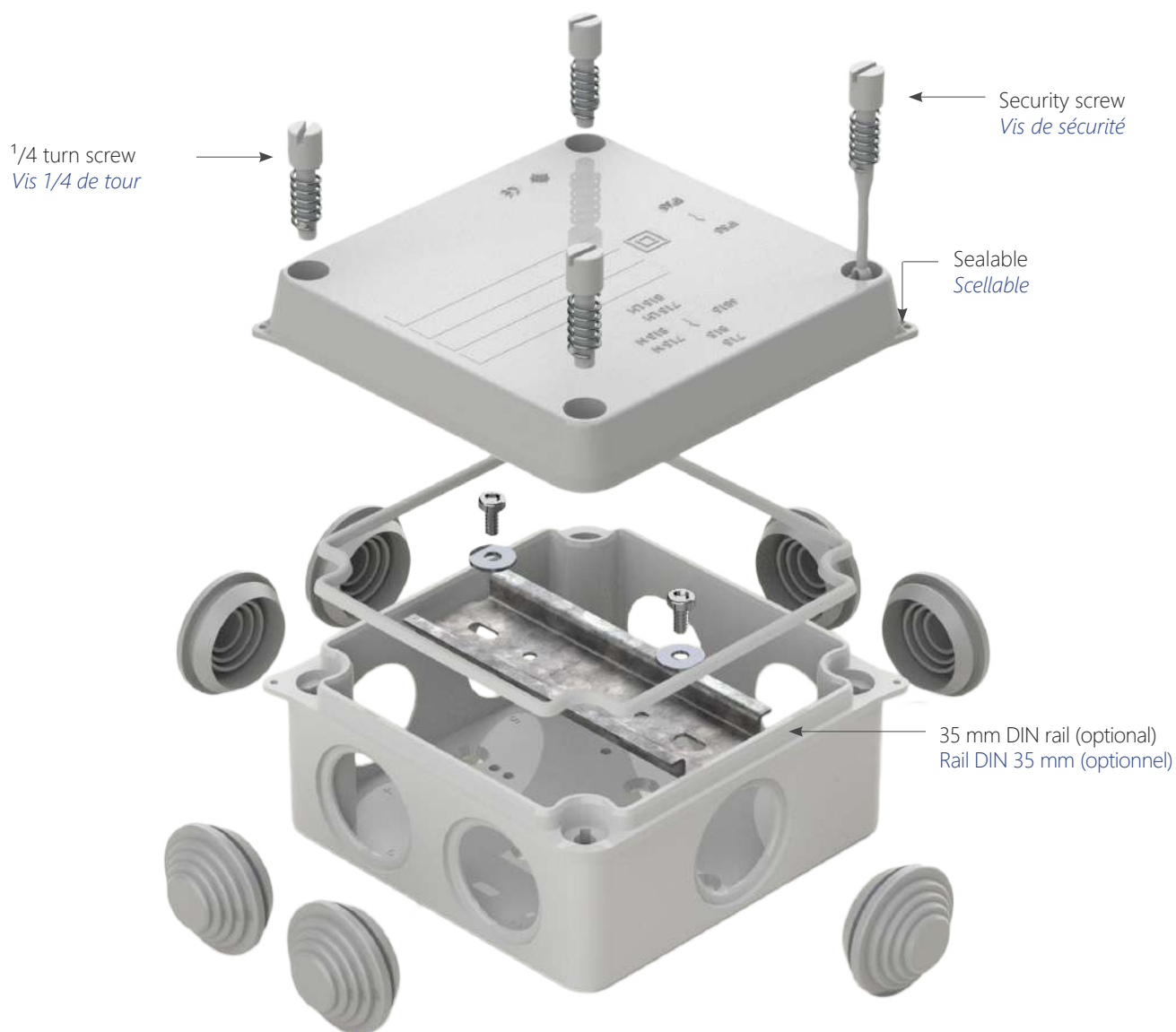

Technical information / *Information technique*

- Complies with Directive 2014/35/EU & 2011/65/EU (RoHS).
- Manufactured under EN 60670-22.
- Dimensions: Width x Height x Depth (mm).

- Conforme à la Directive 2014/35/EU et 2011/65/EU (RoHS).
- En accord avec EN 60670-22.
- Dimensions: Largeur x Hauteur x Profondeur (mm).

Advantages / *Avantages*

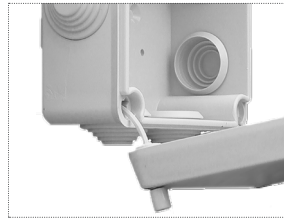

Security screw
Vis de sécurité



35 mm DIN rail (optional)
Rail DIN 35 mm (optionnel)



1/4 turn screw
Vis 1/4 de tour



Transparent lid (optional)
Couvercles transparents (optionnel)



Easy pre-cut openings
Gradins faciles à couper



Certification
Certification

Technical logos / *Logos techniques*



IP55-65 / *IP55-65*



RoHS / *RoHS*



IK07-8-9 / *IK07-8-9*



Halogen Free / *Sans Halogène*



Class II / *Class II*



CE Certification / *Certification CE*



GWT 650°C / *650°C GWT*



Certification / *Certification*

Download / *Télécharger*



More information



Plus d'information

With cones / Avec gradins

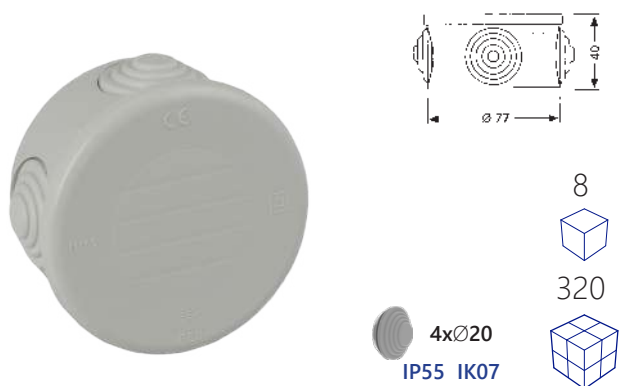

Ref. 665

Ref. 100665

Internal dimensions $\varnothing 70 \times 35$. Pressure closing.
 Ref. 100665 4 pre-cut openings.
*Dimensions intérieures $\varnothing 70 \times 35$. Fermeture à pression.
 Réf. 100665 4 Pré découpé.*

4x $\varnothing 20$
 IP55 IK07

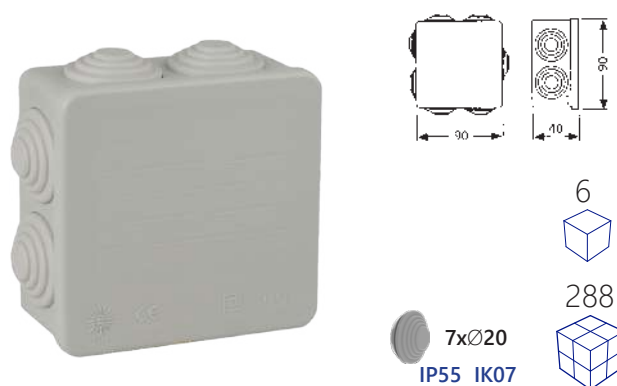

Ref. 604

Internal dimensions $80 \times 80 \times 35$. Pressure closing.
Dimensions intérieures $80 \times 80 \times 35$. Fermeture à pression.

7x $\varnothing 20$
 IP55 IK07

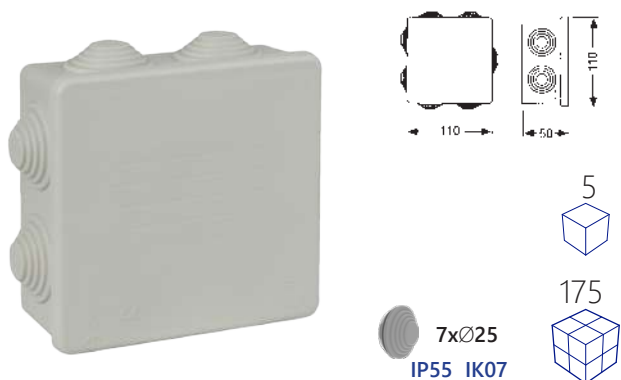

Ref. 615

Internal dimensions $100 \times 100 \times 45$. Pressure closing.
Dimensions intérieures $100 \times 100 \times 45$. Fermeture à pression.

7x $\varnothing 25$
 IP55 IK07

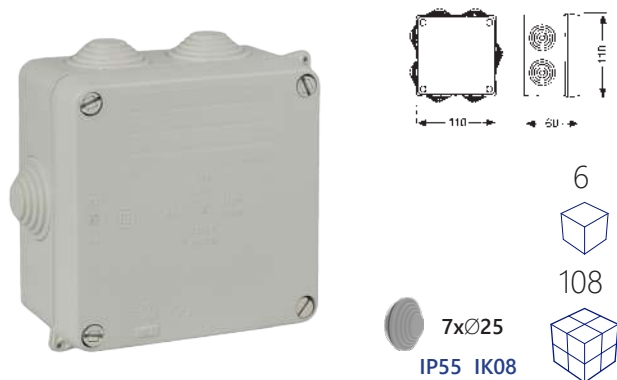

Ref. 715

Internal dimensions $100 \times 100 \times 55$. $\frac{1}{4}$ turn screw. Sealable.
Dimensions intérieures $100 \times 100 \times 55$. Vis $\frac{1}{4}$ de tour. Scellable.

7x $\varnothing 25$
 IP55 IK08

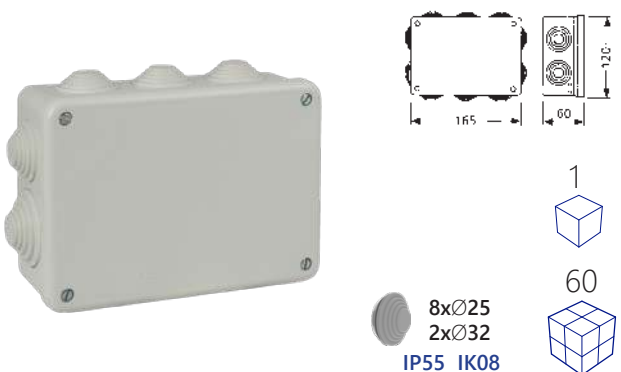

Ref. 616

Internal dimensions $153 \times 110 \times 55$. Metal screw.
Dimensions intérieures $153 \times 110 \times 55$. Vis en métal.

8x $\varnothing 25$
 2x $\varnothing 32$
 IP55 IK08

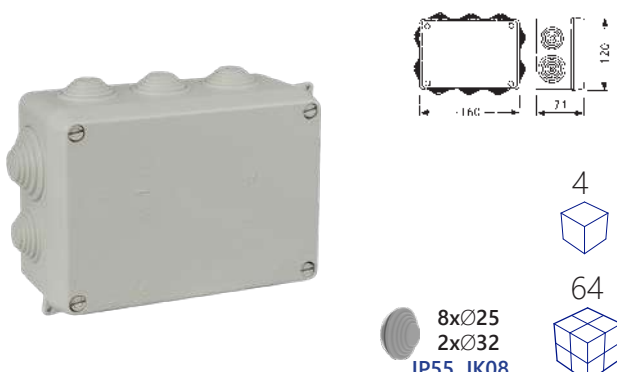

Ref. 716

Internal dimensions $153 \times 110 \times 55$. $\frac{1}{4}$ turn screw. Sealable.
Dimensions intérieures $153 \times 110 \times 55$. Vis $\frac{1}{4}$ de tour. Scellable.

8x $\varnothing 25$
 2x $\varnothing 32$
 IP55 IK08

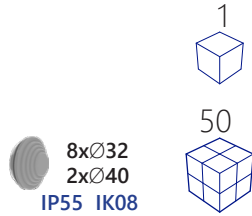
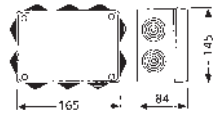

Ref. 717

Internal dimensions 160x135x70. ¼ turn screw. Sealable.
Dimensions intérieures 160x135x70. Vis ¼ de tour. Scellable.

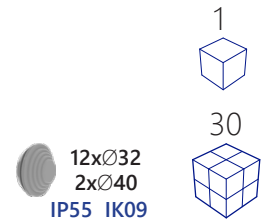
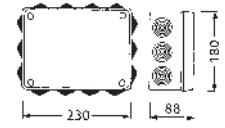

Ref. 686

Internal dimensions 220x170x80. ¼ turn screw. Sealable.
Dimensions intérieures 220x170x80. Vis ¼ de tour. Scellable.

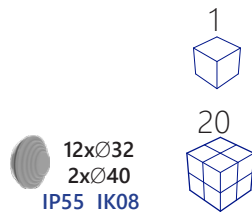
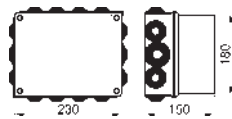

Ref. 686A

Internal dimensions 220x170x140. ¼ turn screw. Sealable.
Dimensions intérieures 220x170x140. Vis ¼ de tour. Scellable.

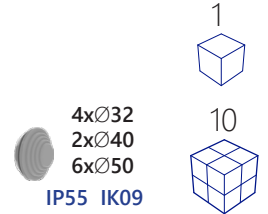
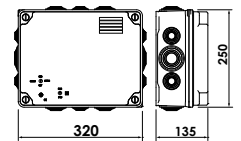

Ref. 100888

Internal dimensions 310x240x125. Plastic screw. Sealable.
Dimensions intérieures 310x240x125. Vis en plastique. Scellable.

Without cones / *Sans gradins*

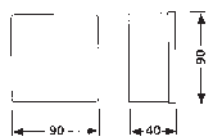

IP55 IK07

Ref. 604C

Internal dimensions 80x80x35. Pressure closing.
Dimensions intérieures 80x80x35. Fermeture à pression.

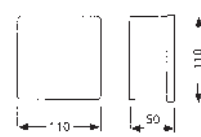

IP55 IK07

Ref. 615C

Internal dimensions 100x100x45. Pressure closing.
Dimensions intérieures 100x100x45. Fermeture à pression.

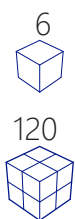
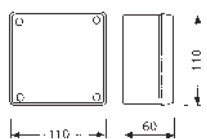

IP65 IK08

Ref. 815

Internal dimensions 100x100x55. 1/4 turn screw. Sealable.
Dimensions intérieures 100x100x55. Vis 1/4 de tour. Scellable.

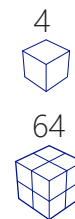
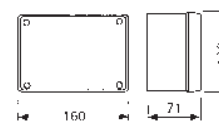

IP65 IK08

Ref. 816

Internal dimensions 153x110x55. 1/4 turn screw. Sealable.
Dimensions intérieures 153x110x55. Vis 1/4 de tour. Scellable.

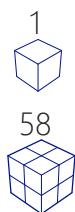
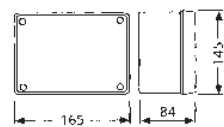

IP65 IK08

Ref. 817

Internal dimensions 160x135x70. 1/4 turn screw. Sealable.
Dimensions intérieures 160x135x70. Vis 1/4 de tour. Scellable.

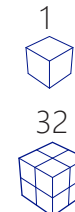
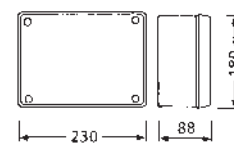

IP65 IK08

Ref. 886

Internal dimensions 220x170x80. 1/4 turn screw. Sealable.
Dimensions intérieures 220x170x80. Vis 1/4 de tour. Scellable.

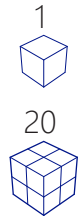
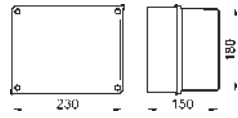

IP65 IK08

Ref. 886A

Internal dimensions 220x170x140. ¼ turn screw. Sealable.
Dimensions intérieures 220x170x140. Vis ¼ de tour. Scellable.

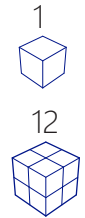
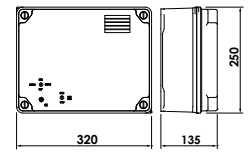

IP65 IK07

Ref. 100887

Internal dimensions 310x240x125. Plastic screw. Sealable.
Dimensions intérieures 310x240x125. Vis en plastique. Scellable.

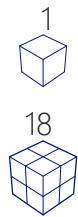
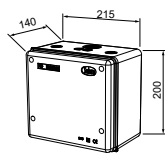

IP65 IK08

Ref. 818A

Internal dimensions 207x192x131. ¼ turn screw.
Dimensions intérieures 207x192x131. Vis ¼ de tour.

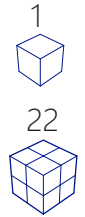
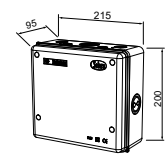

IP65 IK08

Ref. 818B

Internal dimensions 207x192x86. ¼ turn screw.
Dimensions intérieures 207x192x86. Vis ¼ de tour.

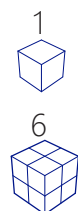
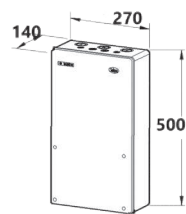

IP65 IK08

Ref. 820P

Internal dimensions 263x493x129. ¼ turn screw.
Dimensions intérieures 263x493x129. Vis ¼ de tour.

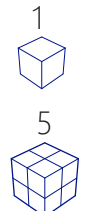
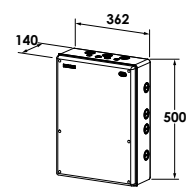

IP65 IK08

Ref. 821P

Internal dimensions 355x493x129. ¼ turn screw.
Dimensions intérieures 355x493x129. Vis ¼ de tour.

Black / Noir

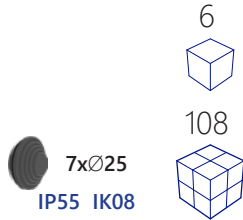
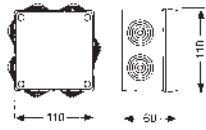

Ref. 715N

Internal dimensions 100x100x55. ¼ turn screw. Sealable.
Dimensions intérieures 100x100x55. Vis ¼ de tour. Scellable.

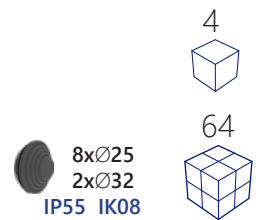
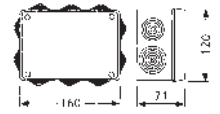

Ref. 716N

Internal dimensions 153x110x55. ¼ turn screw. Sealable.
Dimensions intérieures 153x110x55. Vis ¼ de tour. Scellable.

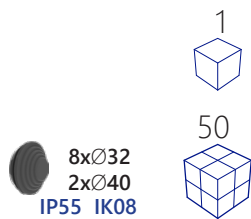
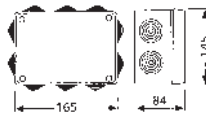

Ref. 717N

Internal dimensions 160x135x70. ¼ turn screw. Sealable.
Dimensions intérieures 160x135x70. Vis ¼ de tour. Scellable.

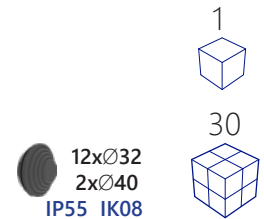
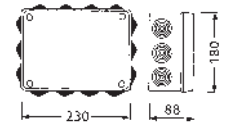

Ref. 686N

Internal dimensions 220x170x80. ¼ turn screw. Sealable.
Dimensions intérieures 220x170x80. Vis ¼ de tour. Scellable.

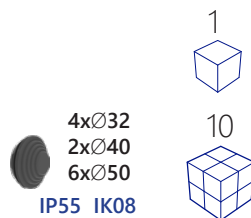
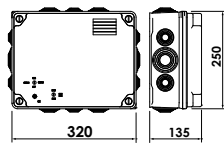

Ref. 100888N

Internal dimensions 310x240x125. Plastic screw. Sealable.
Dimensions intérieures 310x240x125. Vis en plastique. Scellable.

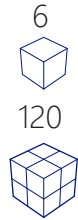
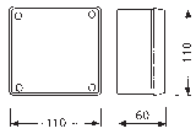

IP65 IK08

Ref. 815N

Internal dimensions 100x100x55. ¼ turn screw. Sealable.
Dimensions intérieures 100x100x55. Vis ¼ de tour. Scellable.

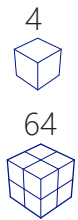
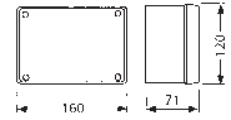

IP65 IK08

Ref. 816N

Internal dimensions 153x110x55. ¼ turn screw. Sealable.
Dimensions intérieures 153x110x55. Vis ¼ de tour. Scellable.

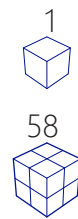
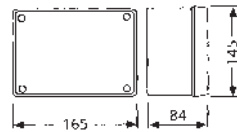

IP65 IK08

Ref. 817N

Internal dimensions 160x135x70. ¼ turn screw. Sealable.
Dimensions intérieures 160x135x70. Vis ¼ de tour. Scellable.

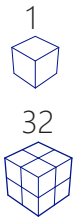
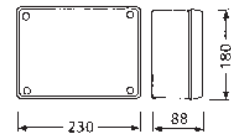

IP65 IK08

Ref. 886N

Internal dimensions 220x170x80. ¼ turn screw. Sealable.
Dimensions intérieures 220x170x80. Vis ¼ de tour. Scellable.

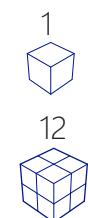
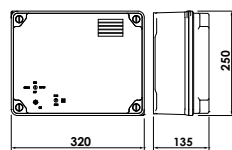

IP65 IK08

Ref. 100887N

Internal dimensions 310x240x125. Plastic screw. Sealable.
Dimensions intérieures 310x240x125. Vis en plastique. Scellable.

With transparent lid / Avec couvercle transparent

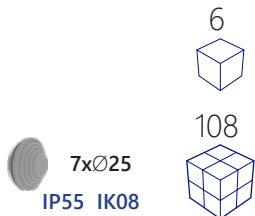
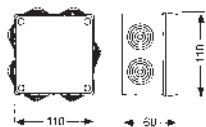

Ref. 715TP

Internal dimensions 100x100x55. ¼ turn screw. Sealable.
 Dimensions intérieures 100x100x55. Vis ¼ de tour. Scellable.

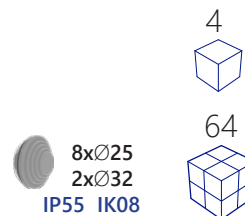
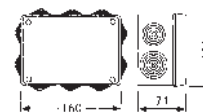

Ref. 716TP

Internal dimensions 153x110x55. ¼ turn screw. Sealable.
 Dimensions intérieures 153x110x55. Vis ¼ de tour. Scellable.

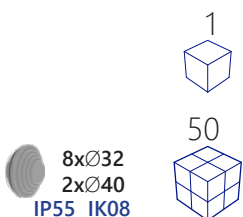
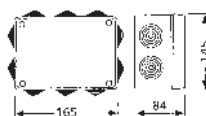

Ref. 717TP

Internal dimensions 160x135x70. ¼ turn screw. Sealable.
 Dimensions intérieures 160x135x70. Vis ¼ de tour. Scellable.

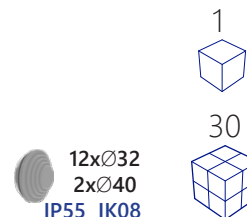

Ref. 686TP

Internal dimensions 220x170x80. ¼ turn screw. Sealable.
 Dimensions intérieures 220x170x80. Vis ¼ de tour. Scellable.

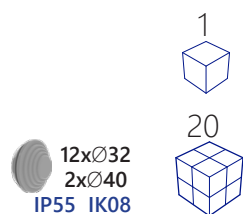
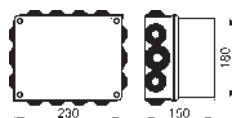

Ref. 686ATP

Internal dimensions 220x170x140. ¼ turn screw. Sealable.
 Dimensions intérieures 220x170x140. Vis ¼ de tour. Scellable.

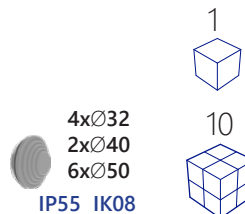
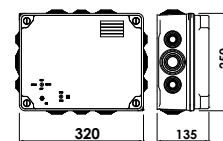

Ref. 100888TP

Internal dimensions 310x240x125. Plastic screw. Sealable.
 Dimensions intérieures 310x240x125. Vis en plastique. Scellable.

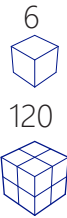
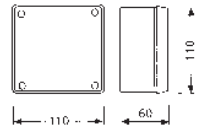

IP65 IK08

Ref. 6815

Internal dimensions 100x100x55. ¼ turn screw. Sealable.
Dimensions intérieures 100x100x55. Vis ¼ de tour. Scellable.

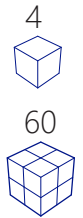
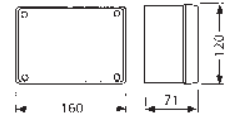

IP65 IK08

Ref. 6816

Internal dimensions 153x110x55. ¼ turn screw. Sealable.
Dimensions intérieures 153x110x55. Vis ¼ de tour. Scellable.

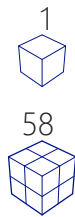
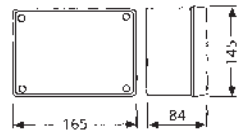

IP65 IK08

Ref. 6817

Internal dimensions 160x135x70. ¼ turn screw. Sealable.
Dimensions intérieures 160x135x70. Vis ¼ de tour. Scellable.

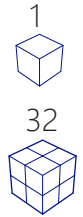
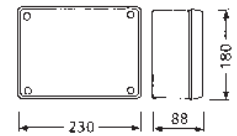

IP65 IK08

Ref. 6886

Internal dimensions 220x170x80. ¼ turn screw. Sealable.
Dimensions intérieures 220x170x80. Vis ¼ de tour. Scellable.

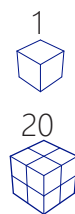
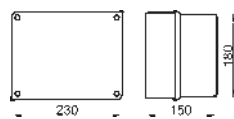

IP65 IK08

Ref. 886ATP

Internal dimensions 220x170x140. ¼ turn screw. Sealable.
Dimensions intérieures 220x170x140. Vis ¼ de tour. Scellable.

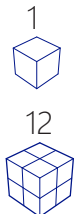
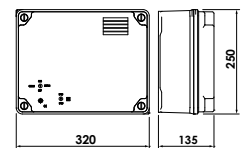

IP65 IK08

Ref. 100887TP

Internal dimensions 310x240x125. Plastic screw. Sealable.
Dimensions intérieures 310x240x125. Vis en plastique. Scellable.

With DIN rail / Avec rail DIN

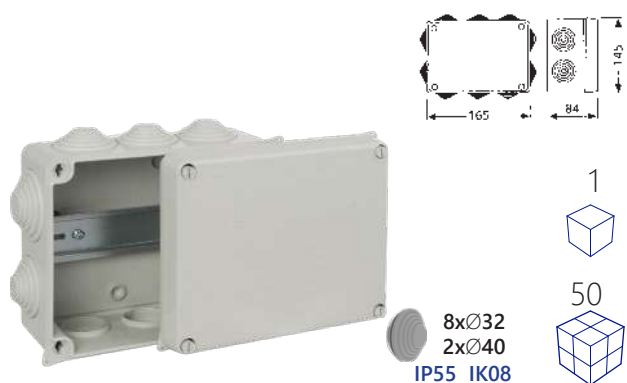

Ref. 717G

Internal dimensions 160x135x70. ¼ turn screw. Sealable.
 Dimensions intérieures 160x135x70. Vis ¼ de tour. Scellable.

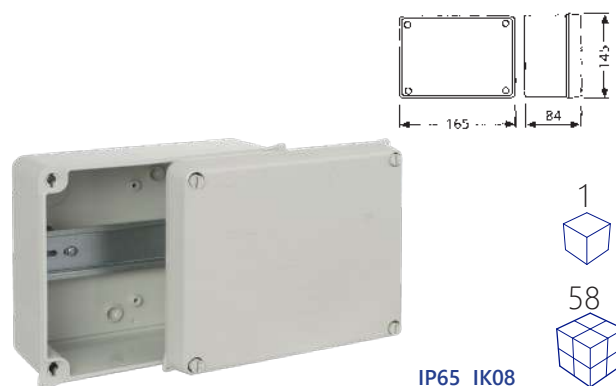

Ref. 817G

Internal dimensions 160x135x70. ¼ turn screw. Sealable.
 Dimensions intérieures 160x135x70. Vis ¼ de tour. Scellable.

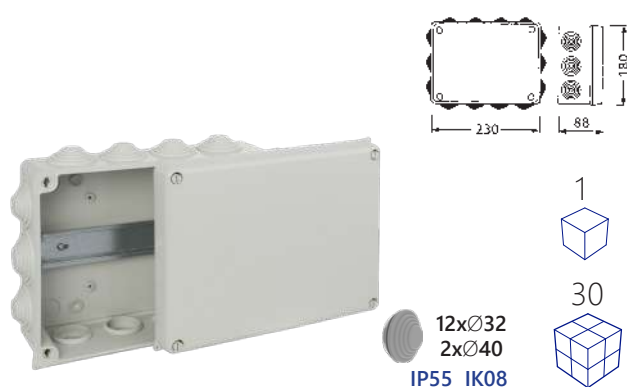

Ref. 686G

Internal dimensions 220x170x80. ¼ turn screw. Sealable.
 Dimensions intérieures 220x170x80. Vis ¼ de tour. Scellable.

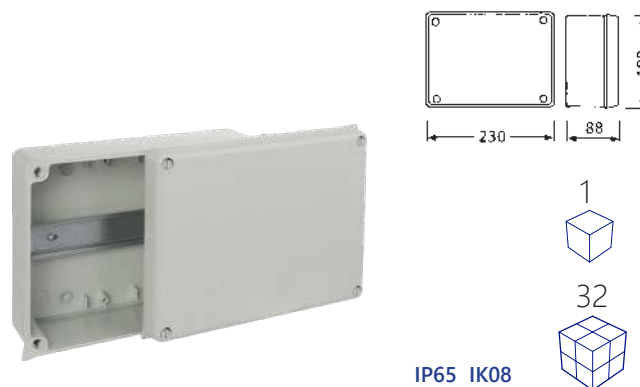

Ref. 886G

Internal dimensions 220x170x80. ¼ turn screw. Sealable.
 Dimensions intérieures 220x170x80. Vis ¼ de tour. Scellable.

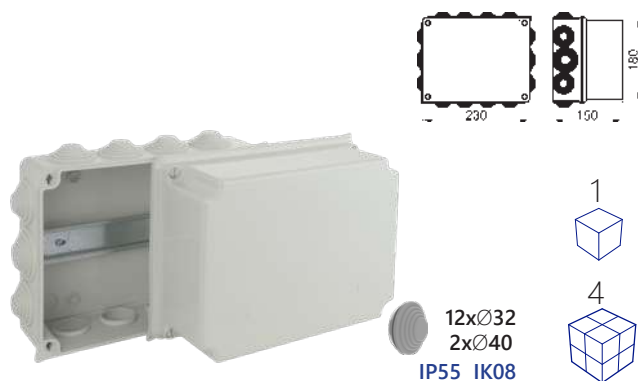

Ref. 686AG

Internal dimensions 220x170x140. ¼ turn screw. Sealable.
 Dimensions intérieures 220x170x140. Vis ¼ de tour. Scellable.

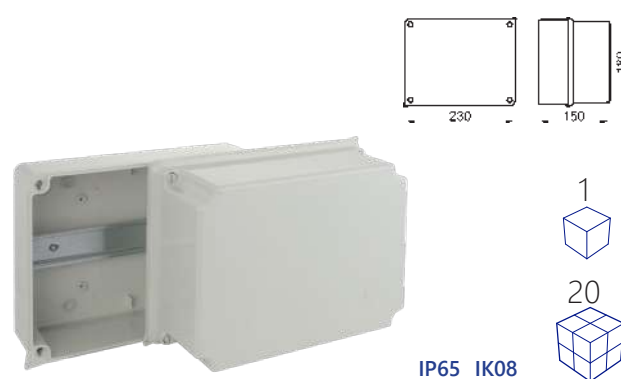

Ref. 886AG

Internal dimensions 220x170x140. ¼ turn screw. Sealable.
 Dimensions intérieures 220x170x140. Vis ¼ de tour. Scellable.

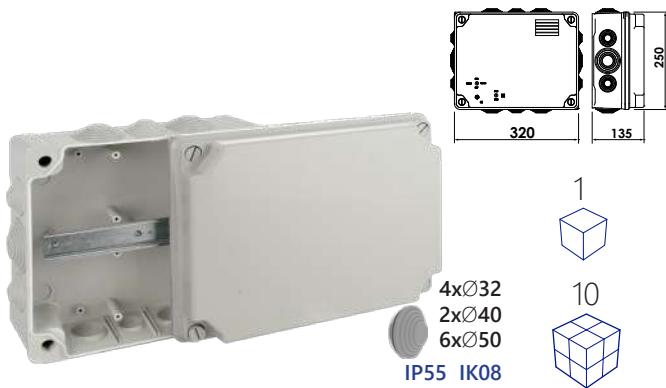

Ref. 100888G

Internal dimensions 310x240x125. Plastic screw. Sealable.
Dimensions intérieures 310x240x125. Vis en plastique. Scellable.

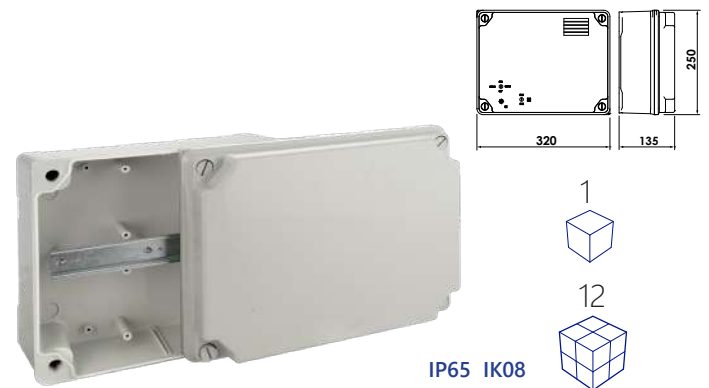

Ref. 100887G

Internal dimensions 310x240x125. Plastic screw. Sealable.
Dimensions intérieures 310x240x125. Vis en plastique. Scellable.

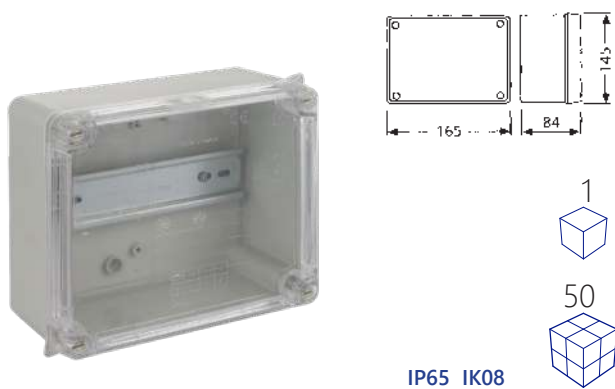

Ref. 6817G

Internal dimensions 160x135x70. ¼ turn screw. Sealable.
Dimensions intérieures 160x135x70. Vis ¼ de tour. Scellable.



Ref. 6886G

Internal dimensions 220x170x80. ¼ turn screw. Sealable.
Dimensions intérieures 220x170x80. Vis ¼ de tour. Scellable.



Ref. 886ATPG

Internal dimensions 220x170x140. ¼ turn screw. Sealable.
Dimensions intérieures 220x170x140. Vis ¼ de tour. Scellable.

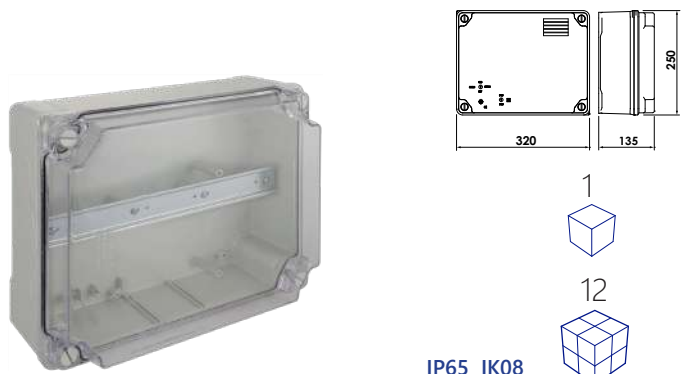

Ref. 100887TPG

Internal dimensions 310x240x125. Plastic screw. Sealable.
Dimensions intérieures 310x240x125. Vis en plastique. Scellable.

Special assembly / Assemblage spécial

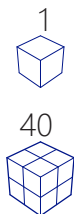
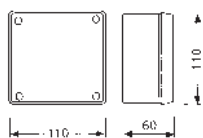

IP54 IK07

Ref. 815-2

Internal dimensions 100x100x55. ¼ turn screw. Sealable.
 Dimensions intérieures 100x100x55. Vis ¼ de tour. Scellable.

1 socket 2P+T, 16A, 250V~, IP54.

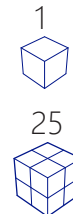
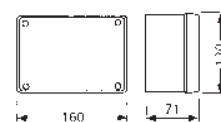

IP54 IK07

Ref. 816-5

Internal dimensions 153x110x55. ¼ turn screw. Sealable.
 Dimensions intérieures 153x110x55. Vis ¼ de tour. Scellable.

2 sockets 2P+T, 16A, 250V~, IP54.

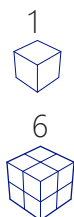
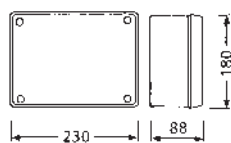

IP44 IK07

Ref. 886-6

Internal dimensions 220x170x80. ¼ turn screw. Sealable.
 Dimensions intérieures 220x170x80. Vis ¼ de tour. Scellable.

1 socket 2P+T, 16A, 250V~, IP54.

1 socket 3P+T 16A, 400V~, IP44.

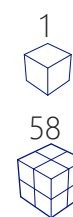
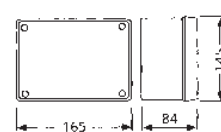

IP44 IK07

Ref. 817-9

Internal dimensions 160x135x70. ¼ turn screw. Sealable.
 Dimensions intérieures 160x135x70. Vis ¼ de tour. Scellable.

2 sockets 2P+T, 16A, 250V~, IP54.

1 socket 3P+T, 16A, 400V~, IP44.

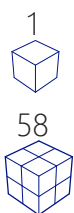
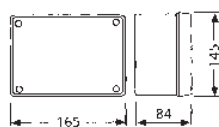

IP54 IK07

Ref. 817-42P

Internal dimensions 160x135x70. ¼ turn screw. Sealable.
 Dimensions intérieures 160x135x70. Vis ¼ de tour. Scellable.

4 sockets 2P+E, 16A, 250V~, IP54.

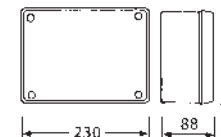

IP54 IK07

Ref. 886-15

Internal dimensions 220x170x80. ¼ turn screw. Sealable.
 Dimensions intérieures 220x170x80. Vis ¼ de tour. Scellable.

6 sockets 2P+T, 16A, 250V~, IP54.

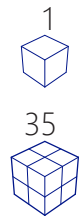
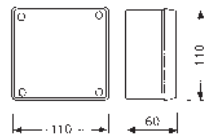

Ref. 815I2P16

Switch 0-1, 2P, 16A. Internal dimensions 100x100x55.
 ¼ turn screw.
*Interrupteur 0-1, 2P, 16A. Dimensions intérieures 100x100x55.
 Vis ¼ de tour.*

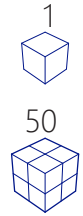
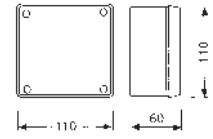

Ref. 815-1

Emergency stop (contact closed).
 Twist release Internal dimensions 100x100x55. ¼ turn screw.
*Arrêt d'urgence (contact fermé). Torsion de presse.
 Dimensions intérieures 100x100x55. Vis ¼ de tour.*

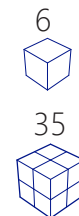
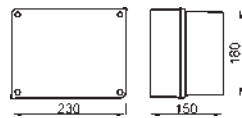

Ref. 886ATPI4P63

Switch 0-1, 4P, 63A. Internal dimensions 220x170x140.
 ¼ turn screw.
*Interrupteur 0-1, 2P, 16A. Dimensions intérieures 220x170x140.
 Vis ¼ de tour.*

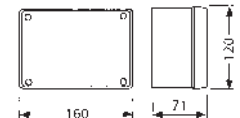

IP65

Ref. 816PR1P160

Ref. 816PR1P160TP

With neutral switch In 160A. Inner dimensions 153x110x65
 ¼ turn screw.
*Avec interrupteur neutre In 160A. Dimensions intérieures
 153x110x65. Vis ¼ de tour.*
 (Ref. 816PR1P160TP with transparent lid / *avec couvercle
 transparent*)



*Any other option you need, quote upon request

Demandez notre devis pour votre coffret équipé et précâblé



Rotary switch / *Interrupteur rotatif*





References <i>Références</i>	Description	Description		
Rotary switch. Red.		<i>Interrupteur rotatif. Rouge.</i>		
IR2A016E9	Switch 0-1, 2P, 16A. 220/440V.	<i>Interrupteur 0-1, 2P, 16A. 220/440V.</i>	1	100
IR2A020E9	Switch 0-1, 2P, 20A. 220/440V.	<i>Interrupteur 0-1, 2P, 20A. 220/440V.</i>	1	100
IR2A025E9	Switch 0-1, 2P, 25A. 220/440V.	<i>Interrupteur 0-1, 2P, 25A. 220/440V.</i>	1	100
IR2A032E9	Switch 0-1, 2P, 32A. 220/440V.	<i>Interrupteur 0-1, 2P, 32A. 220/440V.</i>	1	72
IR2A040E9	Switch 0-1, 2P, 40A. 220/440V.	<i>Interrupteur 0-1, 2P, 40A. 220/440V.</i>	1	72
IR3A016E9	Switch 0-1, 3P, 16A. 220/440V.	<i>Interrupteur 0-1, 3P, 16A. 220/440V.</i>	1	100
IR3A020E9	Switch 0-1, 3P, 20A. 220/440V.	<i>Interrupteur 0-1, 3P, 20A. 220/440V.</i>	1	100
IR3A025E9	Switch 0-1, 3P, 25A. 220/440V.	<i>Interrupteur 0-1, 3P, 25A. 220/440V.</i>	1	100
IR3A032E9	Switch 0-1, 3P, 32A. 220/440V.	<i>Interrupteur 0-1, 3P, 32A. 220/440V.</i>	1	72
IR3A040E9	Switch 0-1, 3P, 40A. 220/440V.	<i>Interrupteur 0-1, 3P, 40A. 220/440V.</i>	1	72
IR3A050E9	Switch 0-1, 3P, 50A. 220/440V.	<i>Interrupteur 0-1, 3P, 50A. 220/440V.</i>	1	30
IR3A063E9	Switch 0-1, 3P, 63A. 220/440V.	<i>Interrupteur 0-1, 3P, 63A. 220/440V.</i>	1	30
IR3A080E9	Switch 0-1, 3P, 80A. 220/440V.	<i>Interrupteur 0-1, 3P, 80A. 220/440V.</i>	1	30
IR3A120E9	Switch 0-1, 3P, 120A. 220/440V.	<i>Interrupteur 0-1, 3P, 120A. 220/440V.</i>	1	30
IR4A016E9	Switch 0-1, 4P, 16A. 220/440V.	<i>Interrupteur 0-1, 4P, 16A. 220/440V.</i>	1	100
IR4A020E9	Switch 0-1, 4P, 20A. 220/440V.	<i>Interrupteur 0-1, 4P, 20A. 220/440V.</i>	1	100
IR4A025E9	Switch 0-1, 4P, 25A. 220/440V.	<i>Interrupteur 0-1, 4P, 25A. 220/440V.</i>	1	100
IR4A032E9	Switch 0-1, 4P, 32A. 220/440V.	<i>Interrupteur 0-1, 4P, 32A. 220/440V.</i>	1	72
IR4A040E9	Switch 0-1, 4P, 40A. 220/440V.	<i>Interrupteur 0-1, 4P, 40A. 220/440V.</i>	1	72
IR4A050E9	Switch 0-1, 4P, 50A. 220/440V.	<i>Interrupteur 0-1, 4P, 50A. 220/440V.</i>	1	30
IR4A063E9	Switch 0-1, 4P, 63A. 220/440V.	<i>Interrupteur 0-1, 4P, 63A. 220/440V.</i>	1	30
IR4A080E9	Switch 0-1, 4P, 80A. 220/440V.	<i>Interrupteur 0-1, 4P, 80A. 220/440V.</i>	1	30
IR4A120E0	Switch 0-1, 4P, 120A. 220/440V.	<i>Interrupteur 0-1, 4P, 120A. 220/440V.</i>	1	30



Rotary switch. Black.		<i>Interrupteur rotatif. Noir.</i>		
IR2A016S6	Switch 0-1, 2P, 16A. 220/440V.	<i>Interrupteur 0-1, 2P, 16A. 220/440V.</i>	1	100
IR2A020S6	Switch 0-1, 2P, 20A. 220/440V.	<i>Interrupteur 0-1, 2P, 20A. 220/440V.</i>	1	100
IR2A025S6	Switch 0-1, 2P, 25A. 220/440V.	<i>Interrupteur 0-1, 2P, 25A. 220/440V.</i>	1	100
IR2A032S6	Switch 0-1, 2P, 32A. 220/440V.	<i>Interrupteur 0-1, 2P, 32A. 220/440V.</i>	1	72
IR2A040S6	Switch 0-1, 2P, 40A. 220/440V.	<i>Interrupteur 0-1, 2P, 40A. 220/440V.</i>	1	72
IR3A016S6	Switch 0-1, 3P, 16A. 220/440V.	<i>Interrupteur 0-1, 3P, 16A. 220/440V.</i>	1	100
IR3A020S6	Switch 0-1, 3P, 20A. 220/440V.	<i>Interrupteur 0-1, 3P, 20A. 220/440V.</i>	1	100
IR3A025S6	Switch 0-1, 3P, 25A. 220/440V.	<i>Interrupteur 0-1, 3P, 25A. 220/440V.</i>	1	100
IR3A032S6	Switch 0-1, 3P, 32A. 220/440V.	<i>Interrupteur 0-1, 3P, 32A. 220/440V.</i>	1	72
IR3A040S6	Switch 0-1, 3P, 40A. 220/440V.	<i>Interrupteur 0-1, 3P, 40A. 220/440V.</i>	1	1
IR3A050S6	Switch 0-1, 3P, 50A. 220/440V.	<i>Interrupteur 0-1, 3P, 50A. 220/440V.</i>	1	---
IR3A063S6	Switch 0-1, 3P, 63A. 220/440V.	<i>Interrupteur 0-1, 3P, 63A. 220/440V.</i>	1	1
IR3A080S6	Switch 0-1, 3P, 80A. 220/440V.	<i>Interrupteur 0-1, 3P, 80A. 220/440V.</i>	1	---





References <i>Références</i>	Description	Description		
	Rotary switch. Black.	Interrupteur rotatif. Noir.		
IR3A120S6	Switch 0-1, 3P, 120A. 220/440V.	Interrupteur 0-1, 3P, 120A. 220/440V.	1	1
IR4A016S6	Switch 0-1, 4P, 16A. 220/440V.	Interrupteur 0-1, 4P, 16A. 220/440V.	1	---
IR4A020S6	Switch 0-1, 4P, 20A. 220/440V.	Interrupteur 0-1, 4P, 20A. 220/440V.	1	---
IR4A025S6	Switch 0-1, 4P, 25A. 220/440V.	Interrupteur 0-1, 4P, 25A. 220/440V.	1	---
IR4A032S6	Switch 0-1, 4P, 32A. 220/440V.	Interrupteur 0-1, 4P, 32A. 220/440V.	1	72
IR4A040S6	Switch 0-1, 4P, 40A. 220/440V.	Interrupteur 0-1, 4P, 40A. 220/440V.	1	72
IR4A050S6	Switch 0-1, 4P, 50A. 220/440V.	Interrupteur 0-1, 4P, 50A. 220/440V.	1	30
IR4A063S6	Switch 0-1, 4P, 63A. 220/440V.	Interrupteur 0-1, 4P, 63A. 220/440V.	1	30
IR4A080S6	Switch 0-1, 4P, 80A. 220/440V.	Interrupteur 0-1, 4P, 80A. 220/440V.	1	---
IR4A120S6	Switch 0-1, 4P, 120A. 220/440V.	Interrupteur 0-1, 4P, 120A. 220/440V.	1	---

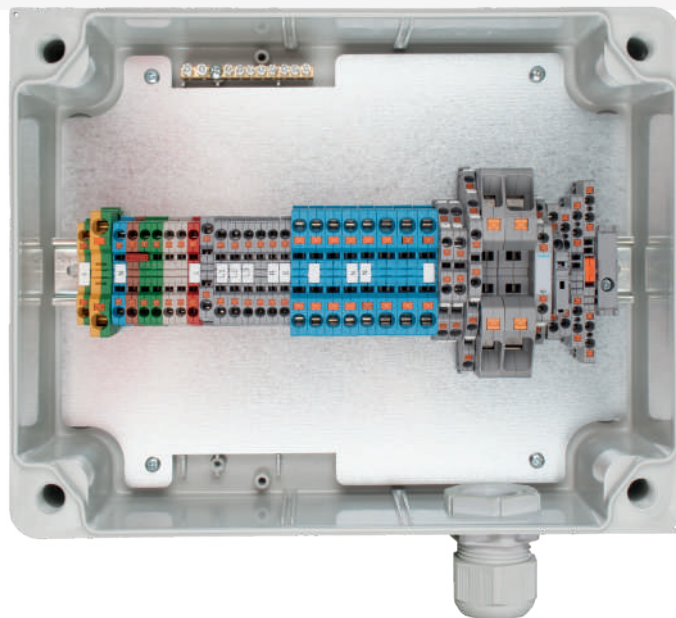

	Rotary 2 way switch. Black.	Commutateur rotatif. Noir.		
IR2B016S6	Switch 1-0-2, 2P, 16A. 220/440V.	Interrupteur 1-0-2, 2P, 16A. 220/440V.	1	---
IR2B020S6	Switch 1-0-2, 2P, 20A. 220/440V.	Interrupteur 1-0-2, 2P, 20A. 220/440V.	1	100
IR2B025S6	Switch 1-0-2, 2P, 25A. 220/440V.	Interrupteur 1-0-2, 2P, 25A. 220/440V.	1	100
IR2B032S6	Switch 1-0-2, 2P, 32A. 220/440V.	Interrupteur 1-0-2, 2P, 32A. 220/440V.	1	---
IR2B040S6	Switch 1-0-2, 2P, 40A. 220/440V.	Interrupteur 1-0-2, 2P, 40A. 220/440V.	1	---
IR3B016S6	Switch 1-0-2, 3P, 16A. 220/440V.	Interrupteur 1-0-2, 3P, 16A. 220/440V.	1	---
IR3B020S6	Switch 1-0-2, 3P, 20A. 220/440V.	Interrupteur 1-0-2, 3P, 20A. 220/440V.	1	---
IR3B025S6	Switch 1-0-2, 3P, 25A. 220/440V.	Interrupteur 1-0-2, 3P, 25A. 220/440V.	1	---
IR3B032S6	Switch 1-0-2, 3P, 32A. 220/440V.	Interrupteur 1-0-2, 3P, 32A. 220/440V.	1	---
IR3B040S6	Switch 1-0-2, 3P, 40A. 220/440V.	Interrupteur 1-0-2, 3P, 40A. 220/440V.	1	---
IR3B050S6	Switch 1-0-2, 3P, 50A. 220/440V.	Interrupteur 1-0-2, 3P, 50A. 220/440V.	1	---
IR3B063S6	Switch 1-0-2, 3P, 63A. 220/440V.	Interrupteur 1-0-2, 3P, 63A. 220/440V.	1	---
IR3B080S6	Switch 1-0-2, 3P, 80A. 220/440V.	Interrupteur 1-0-2, 3P, 80A. 220/440V.	1	---
IR3B120S6	Switch 1-0-2, 3P, 120A. 220/440V.	Interrupteur 1-0-2, 3P, 120A. 220/440V.	1	---
IR4B016S6	Switch 1-0-2, 4P, 16A. 220/440V.	Interrupteur 1-0-2, 4P, 16A. 220/440V.	1	---
IR4B020S6	Switch 1-0-2, 4P, 20A. 220/440V.	Interrupteur 1-0-2, 4P, 20A. 220/440V.	1	---
IR4B025S6	Switch 1-0-2, 4P, 25A. 220/440V.	Interrupteur 1-0-2, 4P, 25A. 220/440V.	1	---
IR4B032S6	Switch 1-0-2, 4P, 32A. 220/440V.	Interrupteur 1-0-2, 4P, 32A. 220/440V.	1	---
IR4B040S6	Switch 1-0-2, 4P, 40A. 220/440V.	Interrupteur 1-0-2, 4P, 40A. 220/440V.	1	---
IR4B050S6	Switch 1-0-2, 4P, 50A. 220/440V.	Interrupteur 1-0-2, 4P, 50A. 220/440V.	1	---
IR4B063S6	Switch 1-0-2, 4P, 63A. 220/440V.	Interrupteur 1-0-2, 4P, 63A. 220/440V.	1	---
IR4B080S6	Switch 1-0-2, 4P, 80A. 220/440V.	Interrupteur 1-0-2, 4P, 80A. 220/440V.	1	---
IR4B120S6	Switch 1-0-2, 4P, 120A. 220/440V.	Interrupteur 1-0-2, 4P, 120A. 220/440V.	1	---

Accessories / Accessoires



References <i>Références</i>	Description	Description	
	DIN rail.	Rail DIN.	
TS35/SZ	DIN rail (without hole). 35x7.5. Length 2m. Steel.	Rail DIN. 35x7,5. Longueur 2m. Acier.	2/20



	Cable glands.	Presse-étoupe.	
KIT-PL12G	M12x1.5. Ø cable 3 - 7.	M12x1,5. Ø câble 3 - 7.	60/960
KIT-PL16G	M16x1.5. Ø cable 4.5 - 10.	M16x1,5. Ø câble 4,5 - 10.	60/960
KIT-PL20G	M20x1.5. Ø cable 6 - 12.	M20x1,5. Ø câble 6 - 13.	60/960
KIT-PL25G	M25x1.5. Ø cable 13 - 18.	M25x1,5. Ø câble 13 - 18.	60/480
KIT-PL32G	M32x1.5. Ø cable 18 - 25.	M32x1,5. Ø câble 18 - 25.	40/320
KIT-PL40G	M40x1.5. Ø cable 24 - 32.	M40x1,5. Ø câble 24 - 32.	24/96



	Cones.	Gradins.	
CO-M20	Cone Ø20.	Gradin Ø20.	1/2850
CO-M25/A	Cone Ø25.	Gradin Ø25.	1/1700
CO-M32/A	Cone Ø32.	Gradin Ø32.	1/1100
CO-M40/A	Cone Ø40.	Gradin Ø40.	1/750
CO-M50/A	Cone Ø50.	Gradin Ø50.	1/500



	Fast terminal blocks.	Blocs de bornes rapides.	
CLE24	2 entries: flexible 2.5, rigid 4.	2 entrées: flexible 2,5, rigide 4.	20/600
CLE34	3 entries: flexible 2.5, rigid 4.	3 entrées: flexible 2,5, rigide 4.	20/640
CLE54	5 entries: flexible 2.5, rigid 4.	5 entrées: flexible 2,5, rigide 4.	20/400
CLE4-5	Pack: 2 CLE24, 2 CLE34, 1 CLE54	Pack: 2 CLE24, 2 CLE34, 1 CLE54.	20/320



	Neutral switch.	Interrupteur neutre.	
SEC1P160A	Neutral switch In 160A.	Interrupteur neutre In 160A.	1/120



References Références	Description	Description	
Mounting plate.		Plaque de montage.	
PM817	150 x 130 x 1,5. Use for refs. 717, 817 & 6817.	150 x 130 x 1,5. Utiliser pour réf. 717, 817 et 6817.	1/50
PM820	440 x 200 x 2. Use for ref. 820.	440 x 200 x 2. Utiliser pour réf. 820.	1/10
PM821	440 x 290 x 2. Use for ref. 821.	440 x 290 x 2. Utiliser pour réf. 821.	1/10
PM886	214 x 164 x 1,5. Use for refs. 686, 686A, 886, 886A & 6886.	214 x 164 x 1,5. Utiliser pour réf. 686, 686A, 886, 886A et 6886.	1/20
PM887	295 x 224 x 2 mm. Use for refs. 100888 & 100887.	295 x 224 x 2. Utiliser pour réf. 100888 et 100887.	1/10



12 terminal strip for 2.5 mm² cable.		12 bornes pour câble de 2,5 mm².	
RE2,5/10B	450V. 18A. Couple 0.4Nm. White.	450V. 18A. Couple 0,4Nm. Blanc.	1/1000
RE2,5/10N	450V. 18A. Couple 0.4Nm. Black.	450V. 18A. Couple 0,4Nm. Noir.	1/1000
12 terminal strip for 4 mm² cable.		12 bornes pour câble de 4 mm².	
RE4/10B	450V. 24A. Couple 0.4Nm. White.	450V. 24A. Couple 0,4Nm. Blanc.	1/1000
RE4/10N	450V. 24A. Couple 0.4Nm. Black.	450V. 24A. Couple 0,4Nm. Noir.	1/1000
12 terminal strip for 6 mm² cable.		12 bornes pour câble de 6 mm².	
RE6/10B	450V. 41A. Couple 0.5Nm. White.	450V. 41A. Couple 0,5Nm. Blanc.	1/1000
RE6/10N	450V. 41A. Couple 0.5Nm. Black.	450V. 41A. Couple 0,5Nm. Noir.	1/1000
12 terminal strip for 10 mm² cable.		12 bornes pour câble de 10 mm².	
RE10/10B	450V. 57A. Couple 0.8Nm. White.	450V. 57A. Couple 0,8Nm. Blanc.	1/500
RE10/10N	450V. 57A. Couple 0.8Nm. Black.	450V. 57A. Couple 0,8Nm. Noir.	1/500
12 terminal strip for 16 mm² cable.		12 bornes pour câble de 16 mm².	
RE16/10B	450V. 76A. Couple 1.2Nm. White.	450V. 76A. Couple 1,2Nm. Blanc.	1/300
RE16/10N	450V. 76A. Couple 1.2Nm. Black.	450V. 76A. Couple 1,2Nm. Noir.	1/300
12 terminal strip for 25 mm² cable.		12 bornes pour câble de 25 mm².	
RE25/10B	450V. 100A. Couple 2Nm. White.	450V. 100A. Couple 2Nm. Blanc.	1/100
RE25/10N	450V. 100A. Couple 2Nm. Black.	450V. 100A. Couple 2Nm. Noir.	1/100
12 terminal strip for 35 mm² cable.		12 bornes pour câble de 35 mm².	
RE35/10B	450V. 125A. Couple 2Nm. White.	450V. 125A. Couple 2Nm. Blanc.	1/100
RE35/10N	450V. 125A. Couple 2Nm. Black.	450V. 125A. Couple 2Nm. Noir.	1/100



Caps for fixing holes of sealed boxes.		Bouchons pour trous de fixation pour boîtes étanches.	
TPO-715	To maintain the IP after fixing the box. Valid for all boxes of YBOX Series. Valid for sealed boxes 615, 686, 715, 716, 717 and 100888. Bag of 24 units.	Pour maintenir l'IP après avoir fixé la boîte. Valable pour toutes les boîtes de la série YBOX. Valable pour les boîtes étanches 615, 686, 715, 716, 717 et 100888. Sac de 24 unités.	1/2500

Informative table / *Tableau informatif*

WITH CONES

Ref.	Exterior measures*	Interior measures*	Ø Cones						I.P.	I.K.	Tamper Seal	Colour RAL	Lid
			20	25	32	40	50						
Halogen free EN 60 670 Glow-wire test 650 °C (960 °C upon request)													
665	Ø77 x 40	Ø70 x 35	4	-	-	-	-	IP55	IK08	✗	■ 7035	Pressure lid	
604	90 x 90 x 40	80 x 80 x 35	7	-	-	-	-	IP55	IK08	✗	■ 7035	Pressure lid	
615	110 x 110 x 50	100 x 100 x 45	-	7	-	-	-	IP55	IK08	✗	■ 7035	Pressure lid	
616	165x120x60	153x110x55	-	8	2	-	-	IP55	IK08	✗	■ 7035	Metal screw	
715	110 x 110 x 60	100 x 100 x 55	-	7	-	-	-	IP55	IK08	✓	■ 7035	1/4 turn plastic screw	
715N	110 x 110 x 60	100 x 100 x 55	-	7	-	-	-	IP55	IK08	✓	■ 9011	1/4 turn plastic screw	
715TP	110 x 110 x 60	100 x 100 x 55	-	7	-	-	-	IP55	IK08	✓	■ 7035	1/4 turn plastic screw	
716	160 x 120 x 71	153 x 110 x 65	-	8	2	-	-	IP55	IK08	✓	■ 7035	1/4 turn plastic screw	
716N	160 x 120 x 71	153 x 110 x 65	-	8	2	-	-	IP55	IK08	✓	■ 9011	1/4 turn plastic screw	
716TP	160 x 120 x 71	153 x 110 x 65	-	8	2	-	-	IP55	IK08	✓	■ 7035	1/4 turn plastic screw	
616	165 x 120 x 60	153 x 110 x 55	-	8	2	-	-	IP55	IK08	✗	■ 7035	Metal screw	
717	165 x 145 x 84	160 x 135 x 70	-	-	8	2	-	IP55	IK08	✓	■ 7035	1/4 turn plastic screw	
717G	165 x 145 x 84	160 x 135 x 70	-	-	8	2	-	IP55	IK08	✓	■ 7035	1/4 turn plastic screw	
717N	165 x 145 x 84	160 x 135 x 70	-	-	8	2	-	IP55	IK08	✓	■ 9011	1/4 turn plastic screw	
717TP	165 x 145 x 84	160 x 135 x 70	-	-	8	2	-	IP55	IK08	✓	■ 7035	1/4 turn plastic screw	
686	230 x 180 x 150	220 x 170 x 140	-	-	12	2	-	IP55	IK08	✓	■ 7035	1/4 turn plastic screw	
686A	230 x 180 x 150	220 x 170 x 140	-	-	12	2	-	IP55	IK08	✓	■ 7035	1/4 turn plastic screw	
686AG	230 x 180 x 150	220 x 170 x 140	-	-	12	2	-	IP55	IK09	✓	■ 7035	1/4 turn plastic screw	
686ATP	230 x 180 x 150	220 x 170 x 140	-	-	12	2	-	IP55	IK08	✓	■ 7035	1/4 turn plastic screw	
686G	230 x 180 x 150	220 x 170 x 140	-	-	12	2	-	IP55	IK08	✓	■ 7035	1/4 turn plastic screw	
686N	230 x 180 x 150	220 x 170 x 140	-	-	12	2	-	IP55	IK08	✓	■ 9011	1/4 turn plastic screw	
686TP	230 x 180 x 150	220 x 170 x 140	-	-	12	2	-	IP55	IK08	✓	■ 7035	1/4 turn plastic screw	
100888	320 x 251 x 134	310 x 240 x 125	-	-	4	2	6	IP55	IK08	✓	■ 7035	Plastic screw	
100888N	320 x 251 x 134	310 x 240 x 125	-	-	4	2	6	IP55	IK08	✓	■ 9011	Plastic screw	
100888TP	320 x 251 x 134	310 x 240 x 125	-	-	4	2	6	IP55	IK08	✓	■ 7035	Plastic screw	

WITHOUT CONES

	External measures*	Internal measures*	I.P.	I.K.	Temper Seal	Colour RAL	Lid
Halogen free EN 60 670 Glow-wire test 650 °C (960 °C upon request)							
604C	90 x 90 x 40	80 x 80 x 35	IP55	IK08	✗	■ 7035	Pressure lid
615C	110 x 110 x 50	100 x 100 x 45	IP55	IK08	✗	■ 7035	Pressure lid
815	110 x 110 x 60	100 x 100 x 55	IP65	IK08	✓	■ 7035	1/4 turn plastic screw
815N	110 x 110 x 60	100 x 100 x 55	IP65	IK08	✓	■ 9011	1/4 turn plastic screw
6815	110 x 110 x 60	100 x 100 x 55	IP65	IK08	✓	■ 7035 & Clear lid	1/4 turn plastic screw
816	160 x 120 x 71	153 x 110 x 65	IP65	IK08	✓	■ 7035	1/4 turn plastic screw
816N	160 x 120 x 71	153 x 110 x 65	IP65	IK08	✓	■ 9011	1/4 turn plastic screw
6816	160 x 120 x 71	153 x 110 x 65	IP65	IK08	✓	■ 7035 & Clear lid	1/4 turn plastic screw
817	165 x 145 x 84	160 x 135 x 70	IP65	IK08	✓	■ 7035	1/4 turn plastic screw
817G	165 x 145 x 84	160 x 135 x 70	IP65	IK08	✓	■ 7035	1/4 turn plastic screw
817N	165 x 145 x 84	160 x 135 x 70	IP65	IK08	✓	■ 9011	1/4 turn plastic screw
6817	165 x 145 x 84	160 x 135 x 70	IP65	IK08	✓	■ 7035 & Clear lid	1/4 turn plastic screw
6817G	165 x 145 x 84	160 x 135 x 70	IP65	IK08	✓	■ 7035 & Clear lid	1/4 turn plastic screw
886	230 x 180 x 88	220 x 170 x 80	IP65	IK08	✓	■ 7035	1/4 turn plastic screw
886A	230 x 180 x 150	220 x 170 x 140	IP65	IK08	✓	■ 7035	1/4 turn plastic screw
886AG	230 x 180 x 150	220 x 170 x 140	IP65	IK08	✓	■ 7035	1/4 turn plastic screw
886ATP	230 x 180 x 150	220 x 170 x 140	IP65	IK08	✓	■ 7035	1/4 turn plastic screw
886ATPG	230 x 180 x 150	220 x 170 x 140	IP65	IK08	✓	■ 7035	1/4 turn plastic screw
886G	230 x 180 x 88	220 x 170 x 80	IP65	IK08	✓	■ 7035	1/4 turn plastic screw
886N	230 x 180 x 88	220 x 170 x 80	IP65	IK08	✓	■ 9011	1/4 turn plastic screw
6886	230 x 180 x 88	220 x 170 x 80	IP65	IK08	✓	■ 7035 & Clear lid	1/4 turn plastic screw
6886G	230 x 180 x 88	220 x 170 x 80	IP65	IK08	✓	■ 7035 & Clear lid	1/4 turn plastic screw
887	320 x 250 x 135	310 x 240 x 125	IP65	IK08	✓	■ 7035	Fixed plastic screw
100887	320 x 250 x 135	310 x 240 x 125	IP65	IK08	✓	■ 7035	Plastic screw
100887N	320 x 250 x 135	310 x 240 x 125	IP65	IK08	✓	■ 9011	Plastic screw
100887TP	320 x 250 x 135	310 x 240 x 125	IP65	IK08	✓	■ 7035	Plastic screw
820P	270 x 500 x 140	263 x 493 x 129	IP65	IK08	✓	■ 7035	Inox. Metal screw
821 P	362 x 500 x 140	355 x 493 x 129	IP65	IK08	✓	■ 7035	Inox. Metal screw

G: With din rail
 N: Black colour
 P: Pre-cut sides